

Formas y medidas • *Formes i mides*

Uni (*monocapa / bicapa*)

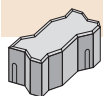

medidas	peso kg.	uds./m ²	uds./palet
22,5 x 11,25 x 8	4,40	39	320

Octogonal (*monocapa / bicapa / granallado*)

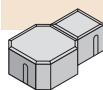

medidas	peso kg.	uds./m ²	uds./palet
23 x 14/9 x 6	3,30	37	384

Románic (*monocapa / bicapa / granallado*)



medidas	peso kg.	uds./m ²	uds./palet
22 x 22/6,5 x 6	4,10	31	240

Hélix (*monocapa / bicapa*)

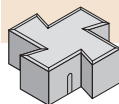

medidas	peso kg.	uds./m ²	uds./palet
24 x 24 x 8	6,5	25	144

Maple (*monocapa / bicapa / granallado*)



medidas	peso kg.	uds./m ²	uds./palet
inscrita en Ø 29,5 x 6	6,3	20	160

Tarquinia (*monocapa / bicapa / granallado*)

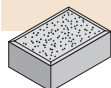

medidas	peso kg.	uds./m ²	uds./palet
14 x 20 x 6	3,60	35,7	280

Palio (*monocapa / bicapa / granallado*)

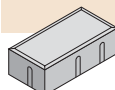

medidas	peso kg.	uds./m ²	uds./palet
12 x 24,2 x 6	3,80	34,4	320

Rectangular (*monocapa / bicapa / granallado*)

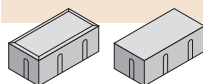

medidas	peso kg.	uds./m ²	uds./palet
20 x 10 x 6	2,50	50	550
20 x 10 x 8	3,50	50	400

Tac (*monocapa / bicapa / granallado*)

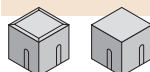

medidas	peso kg.	uds./m ²	uds./palet
10 x 10 x 8	1,75	100	480

Losa con o sin bisel (*monocapa / bicapa / granallado*)

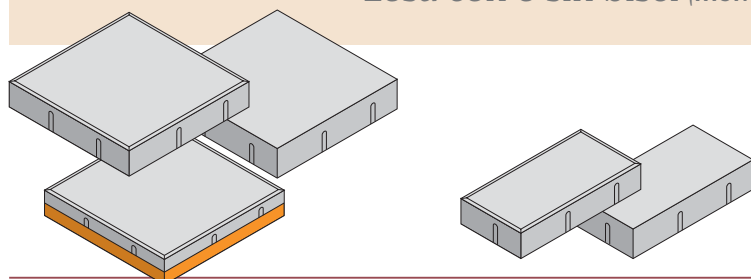

medidas	peso kg.	uds./m ²	uds./palet
40 x 20 x 6	10	12,5	150
40 x 40 x 6	20	6,25	72
40 x 20 x 5	8,5	12,5	150
40 x 40 x 5	17	6,25	72
40 x 40 x 7	14	6,25	48

(4+3 poliestireno extruido)
trans. térmica U = 0,769 W/m² K

Formas y medidas • *Formes i mides*

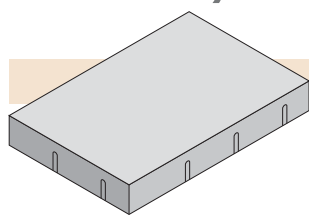

Losa Vallés (*monocapa / granallado*)

medidas	peso kg.	uds./m ²	uds./palet
40 x 60 x 7	36	4,16	32

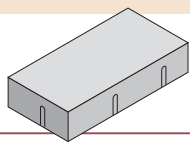
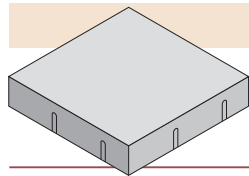

Losa Vallés (*monocapa / bicapa / granallado*)

medidas	peso kg.	uds./m ²	uds./palet
40 x 40 x 7	24	6,25	48
40 x 20 x 7	12	12,5	120

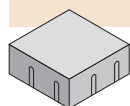

Adoquín Vallés (*monocapa / bicapa / granallado*)

medidas	peso kg.	uds./m ²	uds./palet
20 x 20 x 7	6	25	240
20 x 10 x 7	3	50	400
10 x 10 x 7	1,55	100	480

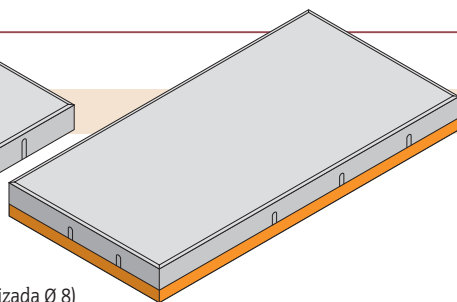
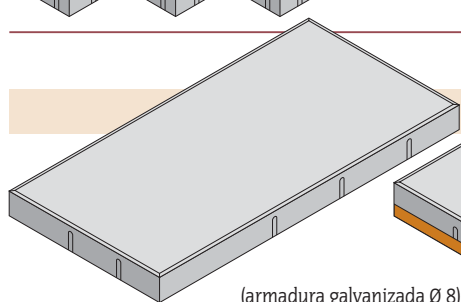

(armadura galvanizada Ø 8)

Big Losa armada (*monocapa / granallado*)

medidas	peso kg.	uds./m ²	uds./palet
100 x 50 x 6	60	2	20
100 x 50 x 9	90	2	10
100 x 50 x 9	60	2	20

(6+3 poliestireno extruido)
Trans. térmica U = 0,761 W/m² K

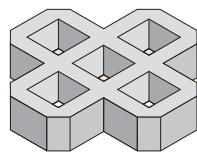

Pradera (*monocapa*)

medidas	peso kg.	uds./m ²	uds./palet
50 x 50 x 8	25,76	4	20

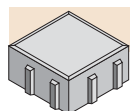

Tac-Verd (*monocapa*)

medidas	peso kg.	uds./m ²	uds./palet
20 x 20 x 8	5,5	25	240

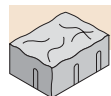

Negro - Mix marrón

Sampietrino (*bicapa envejecido*)

medidas	kg./m ²	uds./m ²	m ² /palet
14 x 19 x 7	150	36	11,7



Mix marrón

Petranova (*bicapa envejecido*)

medidas	kg./m ²	m ² /big bag
10 x variable x 7	150	10



Mix gris

Viena (*bicapa envejecido*)

medidas	kg./m ²	m ² /palet
14,7 x variable x 7	150	10,8



Mix blanco - Mix gris - Mix marrón

Praga (*bicapa envejecido*)

medidas	kg./m ²	m ² /big bag
6 x 6 x 6	130	11